

Article number: 25110265002

Description: ICME Single-phase motor MD80 BL2 1,1KW
2 - 2800 rpm 1x230 Volt 50Hz B14 with starting & running capacitor

Measures

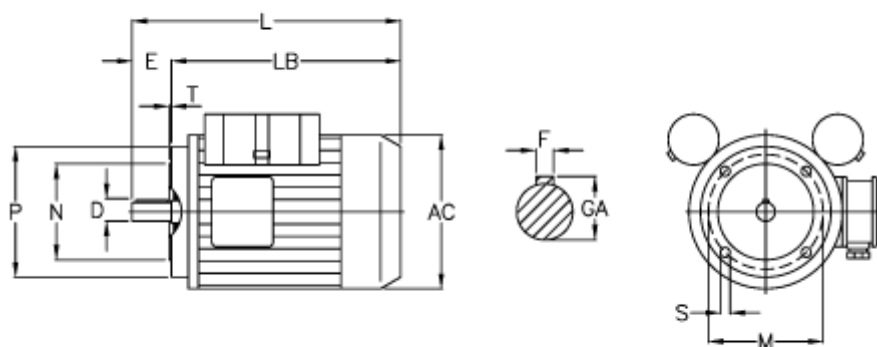

AC = 156	M = 100
D = 19	N = 80
E = 40	P = 120
F = 6	S = M6
GA = 21.5	T = 3
HB = 122	Z = 230
L = 305	
LB = 265	